

**7/8" male 0° / 7/8" female 0°**

PUR 5x1.5 gy UL/CSA+drag chain 8m

Male straight – female straight

7/8" – 7/8", 5-pole

Power cable

Further cable lengths on request.

Plastic housings with good resistance against chemicals and oils.

The resistance to aggressive media should be individually tested for your application. Further details on request.

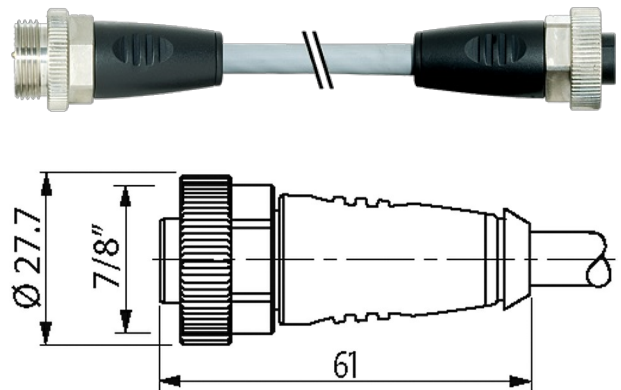
**Link to Product****Illustration**

Product may differ from Image

**Approvals**

cCSAus

\* only for products with UL/CSA approved cable

**Form**

Form 50021

**General data**

Temperature range -25...+85 °C, depending on cable quality

**Cables**

No./diameter of wires	5 × 1.5 mm <sup>2</sup>
Wire isolation	PP (br, wh, bl, bk, gnye)
C-track properties	5 Mio.
Material (jacket)	PUR (UL/CSA)
Outer Ø	8.7 mm ±5%
Bend radius (moving)	10 × outer Ø
Temperature range (fixed)	-50...+80 °C
Temperature range (mobile)	-20...+80 °C
Cable identification	961
Cable Type	3 (PUR)
Approval (cable)	cURus (AWM-Style 21223/10492)
Cable weight [g/m]	129,80
Material (wire)	Cu wire, bare
Resistor (core)	max. 13.3 Ω/km (20 °C)

Single wire Ø (core)	0.15 mm
Construction (core)	84× 0.15 mm (multi-strand wire class 6)
Diameter (core)	5× 1.5 mm <sup>2</sup>
AWG	similar to AWG 16
Material (wire isolation)	PP
Material property (wire isolation)	CFC-, halogen-, cadmium-, silicone- and lead-free
Shore hardness (wire isolation)	60 ±5 D
Wire-Ø incl. isolation	2.3 mm ±5%
Color/numbering of wires	bl, bk, wh, br, num; gnye longitudinally striped
Stranding combination	5 wires twisted around central filler
Shield	no
Material (jacket)	PUR
Material property (jacket)	CFC-, halogen-, cadmium-, silicone- and lead-free, matt, low-adhesion, machine easy to process, abrasion-resistant, hydrolysis and microbial resistant
Shore hardness (jacket)	90 ±5 A
Outer-Ø (jacket)	8.7 mm ±5%
Color (jacket)	gray
chemical resistance	good resistance to oil, gasoline and chemicals (EN 60811-404)
thermal resistance	flame retardant UL 1581 VW1 / CSA FT1 / IEC 60332-1, IEC 60332-2-2
Nominal voltage	1000 V AC
Test voltage	10.0 kV
Current load capacity	to DIN VDE 0298-4
Temperature range (fixed)	-50...+80 °C
Temperature range (mobile)	-20...+80 °C
Bend radius (fixed)	7.5× outer Ø
Bend radius (moving)	10× outer Ø
No. of bending cycles (C-track)	max. 5 Mio. (25 °C)
Traversing distance (C-track)	max. 5 m (horizontal)
Travel speed (C-track)	max. 3.3 m/s
Acceleration (C-track)	max. 5 m/s <sup>2</sup>
Torsion stress	±180°/m
No. of torsion cycles	max. 2 Mio. (25 °C)
Torsion speed	35 cycles/min
Jacket Color	gray

#### Technical Data

Operating voltage	max. 230/400 V AC/DC
Rated surge voltage	3.0 kV
Operating current per contact	max. 12 A
Locking of ports	Screw thread 7/8" (recommended torque 1.5 Nm) self-securing
Protection	IP67 inserted and tightened (EN 60529)

#### Commercial data

country of origin	CZ
customs tariff number	85444290
EAN	4048879138611
eClass	27279218
Packaging unit	1

#### Sketch

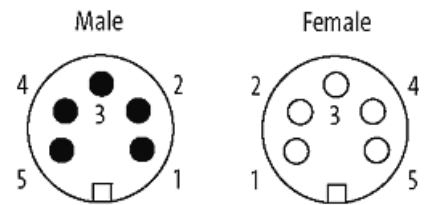
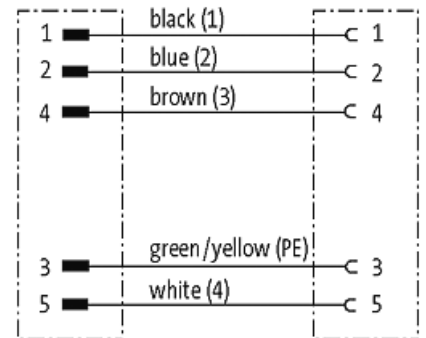
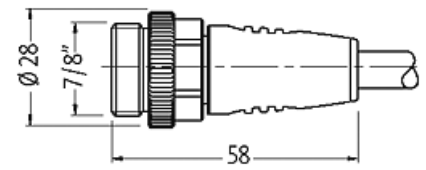

Product may differ from Image